

Delco Alternator

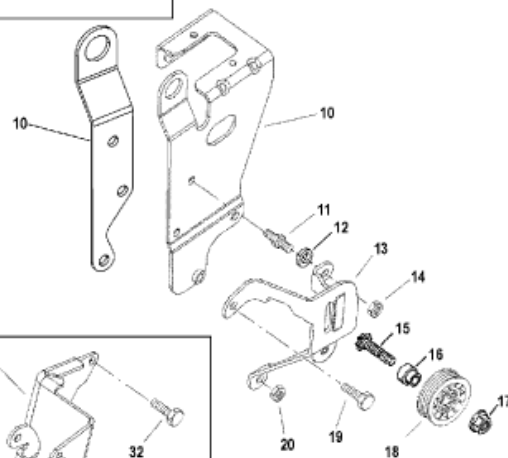

Mando Alternator

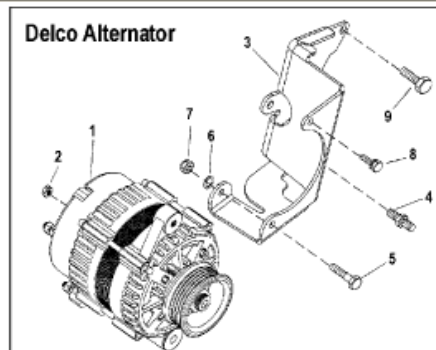
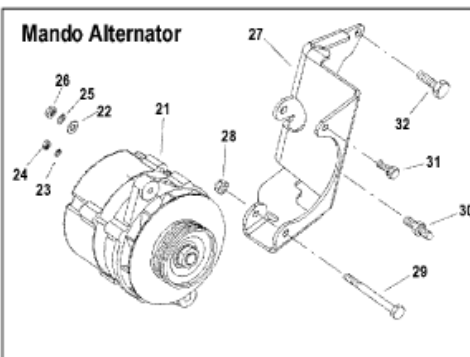

20105

Parts List

Ref	Class	Part	Description	Qty	Comment	Footnote
1		862031T	ALTERNATOR ASSEMBLY (65 Amp)	1	(Non Serviceable - Replace Comp)	
2	11	40021	NUT, (M6)	1		
3		862050T	BRACKET, Alternator	1	(Delco)	
4	16	806591	STUD, Alternator & Seawater Pump	1		
5	10	828213	SCREW, (.312-18 x 1.500)	2		
6	12	57792	WASHER	2		
7	11	859119	NUT, (.312-18)	2		
8	10	40001134	SCREW, (M8 x 25)	1		
9	10	17965	SCREW, (.437-14 x .70)	2		
10		861046	BRACKET-POWER STEERING/LI	1	(Mando Alternator)	
10		807081T	BRACKET, LIFTING EYE	1	(Delco Alternator)	
11	16	861174	STUD (7/16-14 x 1 In.)	2		
12	12	34567	WASHER	2		
13		861045	BRACKET-IDLER	1		
14	11	29553	NUT, (.437-14)	2		
15	43	818381	PINION STUD	1		
16		818380T	BUSHING	1		
17	11	859135	NUT, (.437-20)	1		
18		807757T	PULLEY, Idler	1		
19	10	92913	SCREW, (.437-14 x .750)	2		
20	11	29553	NUT, (.437-14)	1		
21		807653T	ALTERNATOR ASSEMBLY	1	(SEE "ALTERNATOR (MANDO)")	
22	12	96457	WASHER	1		
23	13	26996	LOCKWASHER, (#10)	1		
24	11	79989	NUT, (#10-24)	1		
25	13	26992	LOCKWASHER, (.250)	1		
26	11	94330	NUT, (.250-20)	1		
27		861047	BRACKET, Alternator	1	(Mando)	
28	11	23161	NUT, (.375-24)	1		
29	10	56743	SCREW, (.375-24 x 3.125)	1		
30	16	806591	STUD, Alternator & Seawater Pump	1		
31	10	29198	SCREW AND LOCKWASHER, (.312-18 x 1.500)	1		
32	10	17965	SCREW, (.437-14 x .70)	2		